

Quoin Stone / 3 Brick Course

Plan

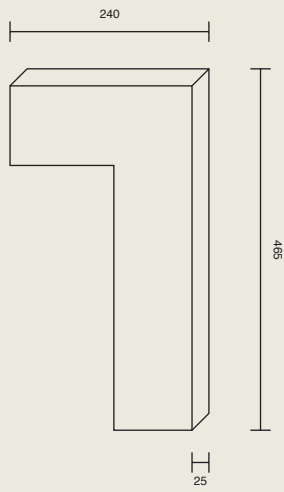

Section

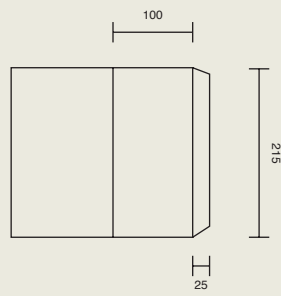

Front Elevation

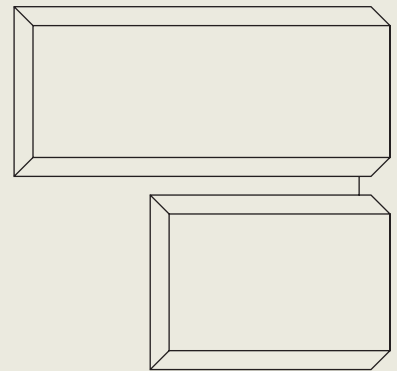

Quoin Stone / 4 Brick Course

Plan

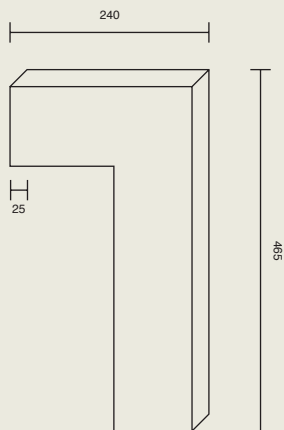

Section

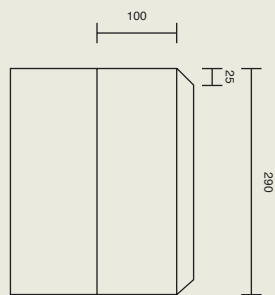

Front Elevation

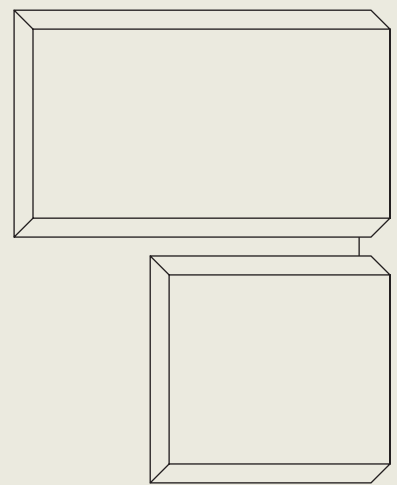

### Stooled Sill

Side Elevation

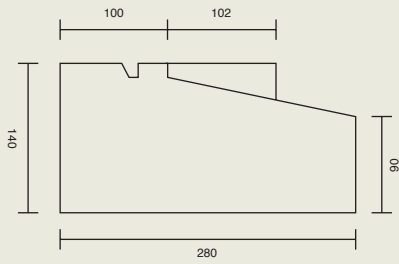

Plan

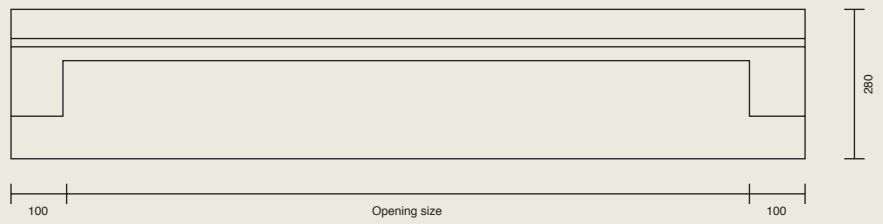

### Slip Sill

Side Elevation

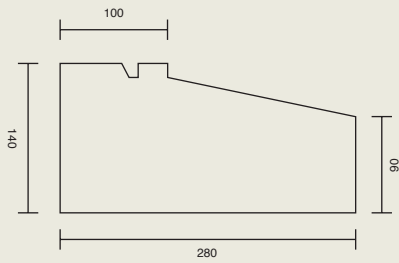

Plan

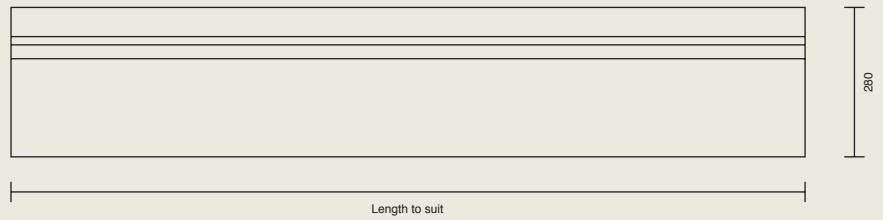

### Keystone Lintel

Elevation

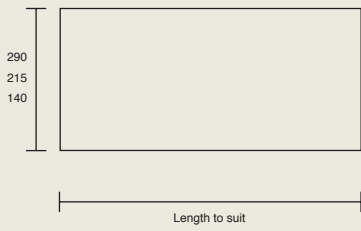

Elevation

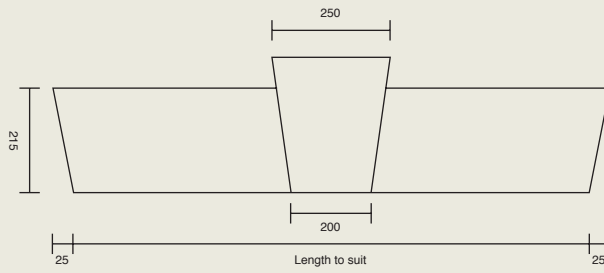

Typical End Elevation

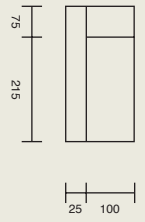

### Keystones

Front Elevation

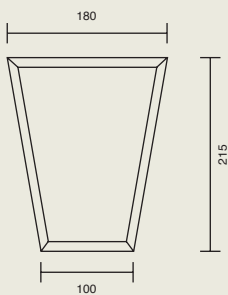

Side Elevation

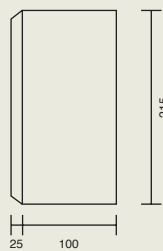

This is Craftstone's basic range of standard products. We also specialise in bespoke architect's originals. All units are available in either a wet-cast or semi-dry finish in a selection of colours. Please contact us for further information.